

EMI/EMC FILTER

IR SERIES



FEATURES

- Inlet filter with fuse holder
- Suitable for the products that must conform to FCC, FTZ.
- Good shield effect by using metal case.
- Meet over voltage category II of IEC 60664 and comply with IEC 60950.
- Uses IEC connector that meets the safety standards of virtually all certifying organization.

APPLICATIONS

- Personal computers and peripherals.
- Digital equipments.
- Measuring and testing instruments.
- Communication equipment.

SPECIFICATIONS

Model	Rated Voltage (AC,DC)	Rated Current	Leakage Current (250V AC)	Temperature Rise	Operating Temperature
IR-02**H	250V	2A	-	40°C max.	-25°C to + 85°C Including temperature rise
IR-04**H	250V	4A	-	45°C max.	
IR-06**H	250V	6A	-	45°C max.	
IR-***0-H	-	*	0.01mA max.	-	
IR-***C-H	-	*	0.075mA max.	-	
IR-***D-H	-	*	0.10mA max.	-	
IR-***2-H	-	*	0.35mA max.	-	
IR-***3-H	-	*	0.50mA max.	-	

Note : Test Voltage : 1500V AC one minute line to earth.
 Insulation Resistance : 300 Mohm min, at 500V DC.
 Voltage Drop : 1V max. at rated current.
 Weight : 78g
 Inlet : Compatible with IEC-60320

Model Number Construction

I	R	02	2	2	H
Input Connector I : IEC Connector	Special Design R : Screw Mounting/ With Fuse Holder	Current Rating : AC rms 02 : 2amp 04 : 4amp 06 : 6amp	Line-Line Cap.Value 1 : 0.1 μ F 2 : 0.22 μ F	Line-Gnd Cap.Value 2 : 2200 pF 3 : 3300 pF C : 330 pF D : 470 pF 0 : None	Output Terminal Style H : Faston Tab #250 S : Solder Lug

Shapes and Dimensions

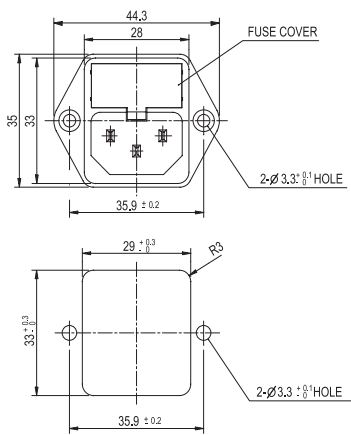

* Panel Cutout dimensions
* Unit : mm

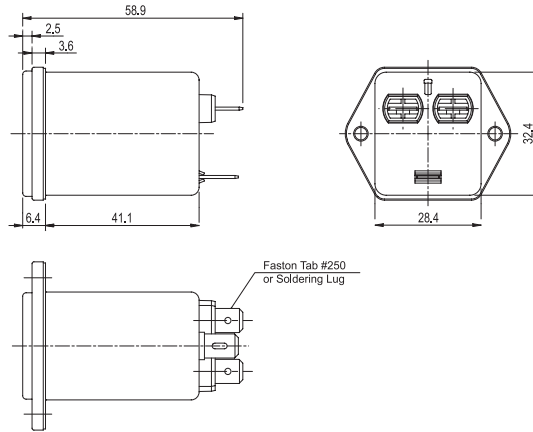

* General tolerance : ±1.0

Attenuation Characteristics

● Common Mode (IR-(02/04/06)*2-H)

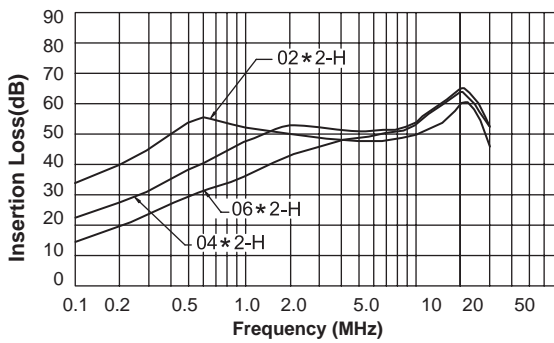

● Differential Mode (IR-(02/04/06) 1*-H)

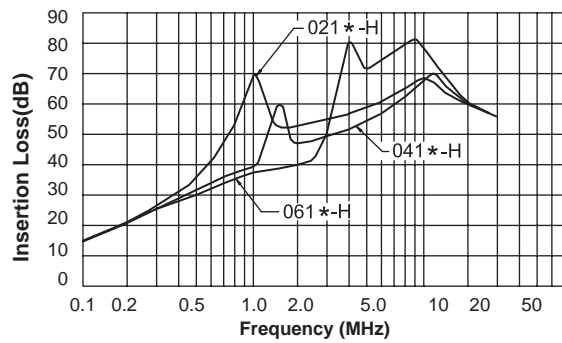

● Common Mode (IR-(02/04/06)*3-H)

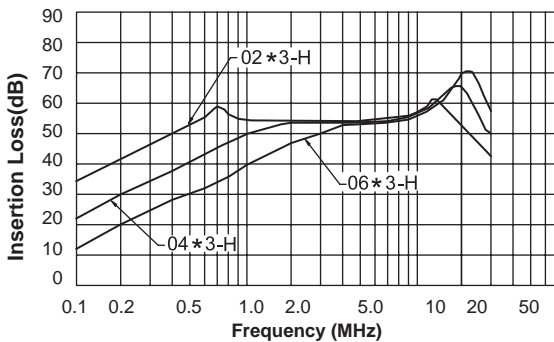

● Differential Mode (IR-(02/04/06)2 *-H)

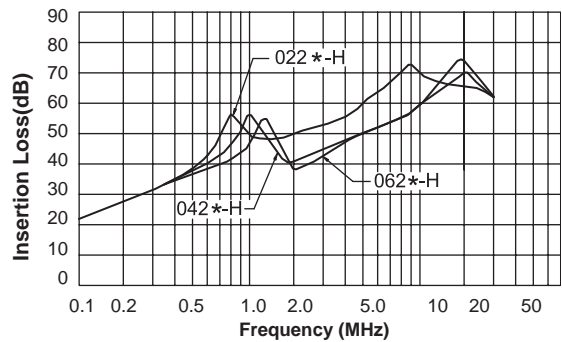

● Circuit Diagram

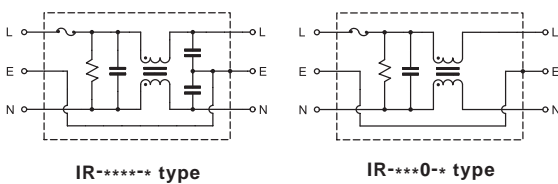

● Measurement configuration

